

## Zawór regulujący przepływ 06 1/4

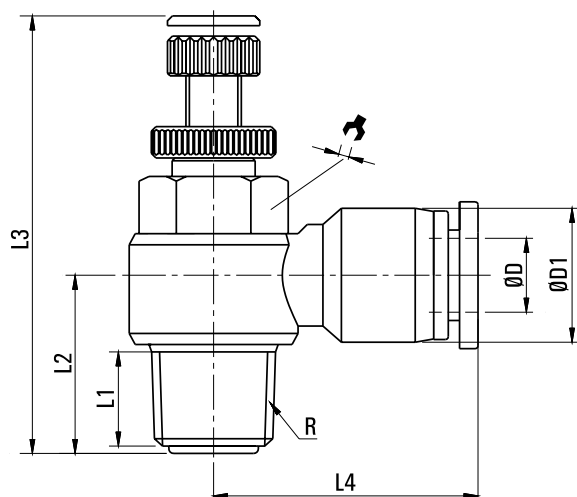

SKU	PU-SC-06-02
Producent	Hi-Tech
waz	O 6 mm
typ	z zaworem
przylacze	G 1/4"
rodzaj gwintu	zewnetrzny
typ zaworu	regulujacy przeplyw



MODEL	ØD	R	L1	L2	L3	L4	ØD1	↻
SC-04-M5	4	M5	3.2	12	32	20.5	11.5	8
SC-04-01	4	1/8"	6.4	14	42	23.5	11.5	12
SC-04-02	4	1/4"	10	18	48	25.5	11.5	14
SC-06-M5	6	M5	3.2	12	32	22	13.5	8
SC-06-01	6	1/8"	6.4	14	42	23.5	13.5	12
SC-06-02	6	1/4"	10	18	48	25.4	13.5	14
SC-06-03	6	3/8"	11.4	20.5	53	29.5	13.5	19
SC-08-01	8	1/8"	6.4	14.5	42	26.5	15	12
SC-08-02	8	1/4"	10	19	48	28.9	15	14
SC-08-03	8	3/8"	11.4	20.5	53	29.8	15	19
SC-08-04	8	1/2"	14	25.5	61	32.5	15	24
SC-10-02	10	1/4"	10	20	48	32.6	19	14
SC-10-03	10	3/8"	11.4	22.5	53	33	19	19
SC-10-04	10	1/2"	14	25.5	61	36	19	24
SC-12-02	12	1/4"	10	20	48	33.5	21.5	14
SC-12-03	12	3/8"	11.4	24	53	35.5	21.5	19
SC-12-04	12	1/2"	14	30	61	36.5	21.5	24