

## Złączka prosta PC-08-3/8"

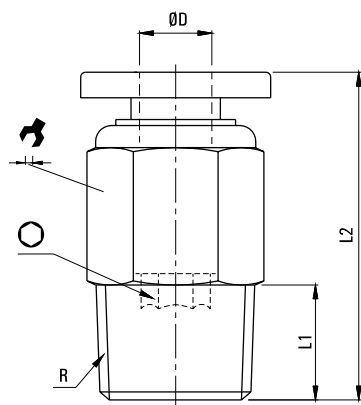

SKU	PU-PC-08-03
Producent	Hi-Tech
waż	Ø 8 mm
typ	prosta
przyłącze	G 3/8"
rodzaj gwintu	zewnetrzny



MODEL	ØD	R	L1	L2	○	↻
PC-04-M5	4	M5	3.5	20.3	2	10
PC-04-01	4	1/8"	7.5	20	3	10
PC-04-02	4	1/4"	9.5	18	3	14
PC-04-03	4	3/8"	10.5	19	3	17
PC-06-M5	6	M5	3.5	21	2	12
PC-06-01	6	1/8"	7.5	20.5	4	12
PC-06-02	6	1/4"	9.5	22.5	4	14
PC-06-03	6	3/8"	10.5	20.5	4	17
PC-08-01	8	1/8"	7.5	25.5	5	14
PC-08-02	8	1/4"	9.5	24.5	5	14
PC-08-03	8	3/8"	10.5	21.5	6	17
PC-08-04	8	1/2"	13.5	25.5	6	21

MODEL	ØD	R	L1	L2	○	↻
PC-10-01	10	1/8"	7.5	29.5	5	17
PC-10-02	10	1/4"	9.5	31	6	17
PC-10-03	10	3/8"	10.5	28.5	8	17
PC-10-04	10	1/2"	13.5	26.5	8	21
PC-12-01	12	1/8"	7.5	31	5	21
PC-12-02	12	1/4"	9.5	33	6	21
PC-12-03	12	3/8"	10.5	30	8	21
PC-12-04	12	1/2"	13.5	32.5	8	21
PC-16-03	16	3/8"	10.5	36.5	8	24
PC-16-04	16	1/2"	13.5	38.5	10	24