

Zawor zwrotno dławiący 08

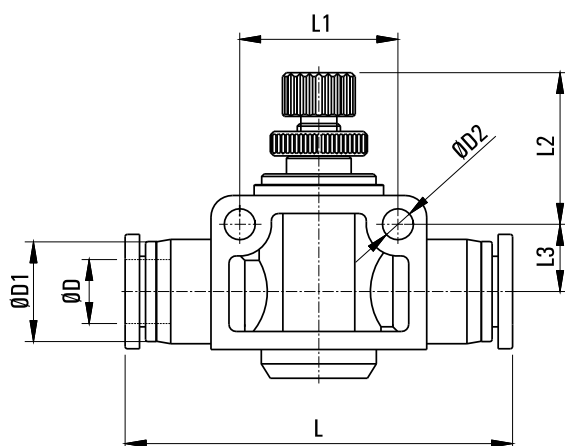

SKU	PA-IQSDRV08
Producent	Hi-Tech
waż	Ø 8 mm
typ	z zaworem
typ zaworu	dławiaco-zwrotny



MODEL	ØD	L	L1	L2	L3	ØD1	ØD2
IQSDR-04	4	40.5	14	16	6.5	10.5	3.2
IQSDR-06	6	48.7	20	25.5	8.5	12.5	4.2
IQSDR-08	8	54.4	22	25	9.5	14	4.2
IQSDR-10	10	64.3	26	29.5	10.5	18	4.2
IQSDR-12	12	74.5	32	27.5	13	20.6	4.2