

Silownik kompaktowy UNITOP 050 X 050 M

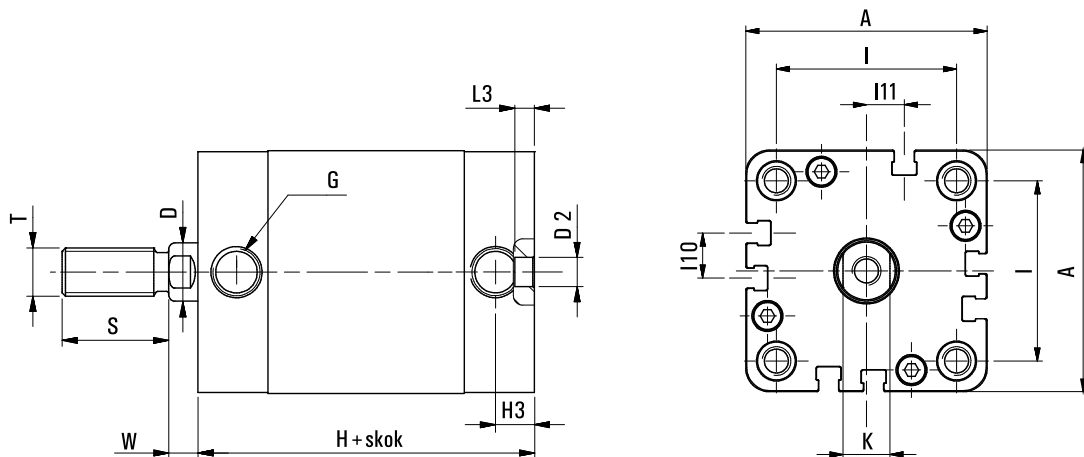

SKU	C-U-050-0050M
Producent	Pneumatig
srednica tłoka [mm]	50
skok silownika [mm]	50
przylacze	G 1/8?
działanie	dwustronne
zakres cisnienia [bar]	1 - 10
zakres temperatur [C]	-10 - 70
korpus	aluminium anodowane
pokrywy	aluminium anodowane
tłoczek	stal nierdzewna AISI 303
uszczelnienia	poliuretan + NBR
amortyzacja	mechaniczna



Ø	A	ØD	ØD2	G	H	H3	I	I10	I11	K	L3	S	T	W
50	67	16	6	G1/8	45,5	8	50	12,5	10,5	13	4	24	M12x1,25	7,5