

Silownik kompaktowy DM 040 X 010 A

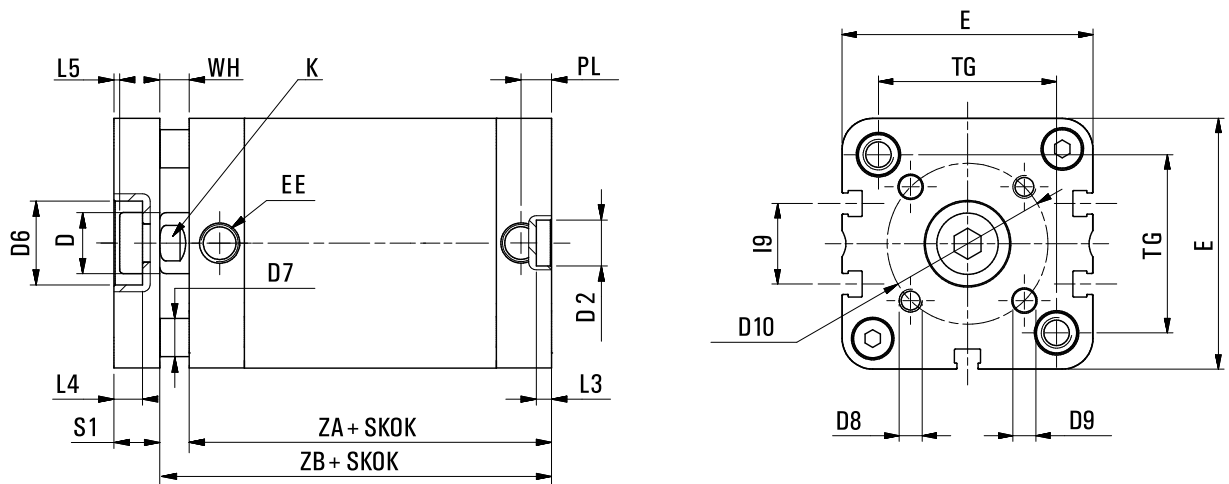

SKU	C-D-040-0010A
Producent	Pneumatig
srednica tłoka [mm]	40
skok silownika [mm]	10
przylacze	G 1/8?
działanie	dwustronne
zakres cisnienia [bar]	1 - 10
zakres temperatur [C]	0 - 80
korpus	aluminium anodowane
pokrywy	odlew aluminium
tłoczyisko	stal nierdzewna AISI 303
uszczelnienia	poliuretan + NBR
amortyzacja	mechaniczna



Ø	ØD	ØD2	ØD6	ØD7	D8	ØD9	ØD10	E	EE	I9	K	L3	L4	L5	PL	S1	TG	WH	ZA	ZB
40	12	9	17	8	M5	5	33	54,5	G1/8	12,8	10	3	6,5	1,5	8	10	38	7	45	52
50	16	12	22	10	M6	6	42	65,5	G1/8	21	13	4	7,5	1,5	8	12	46,5	8	45	53