

Silownik kompaktowy UNITOP 025 X 030 M

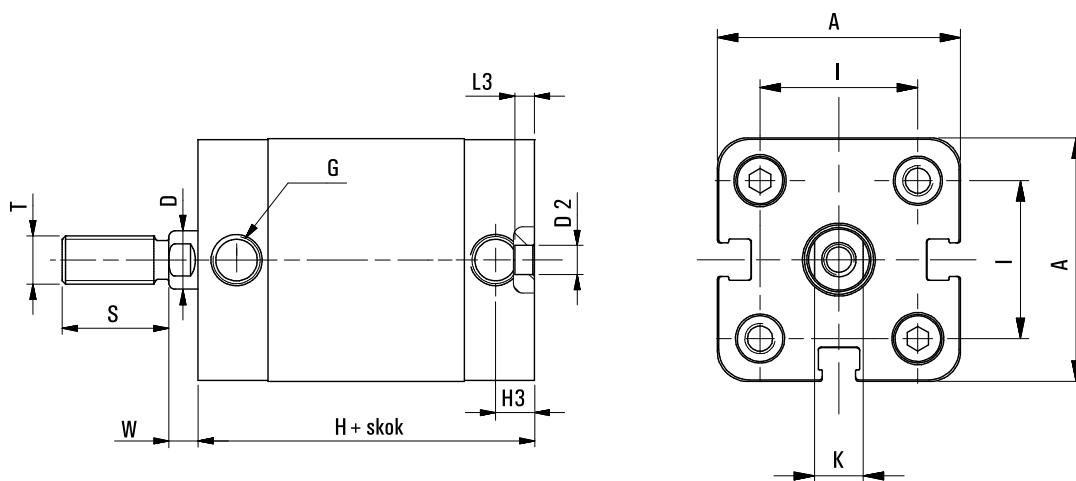

SKU	C-U-025-0030M
Producent	Pneumatig
srednica tłoka [mm]	25
skok silownika [mm]	30
przylacze	M5
działanie	dwustronne
zakres cisnienia [bar]	1 - 10
zakres temperatur [C]	-10 - 70
korpus	aluminium anodowane
pokrywy	aluminium anodowane
tłoczyisko	stal nierdzewna AISI 303
uszczelnienia	poliuretan + NBR
amortyzacja	mechaniczna



Ø	A	ØD	ØD2	G	H	H3	I	K	L3	S	T	W
20	36	10	6	M5	38	8	22	8	4	22	M10x1,25	4,5
25	40	10	6	M5	39,5	8	26	8	4	22	M10x1,25	5,5