

## Silownik kartridżowy 010 X 005

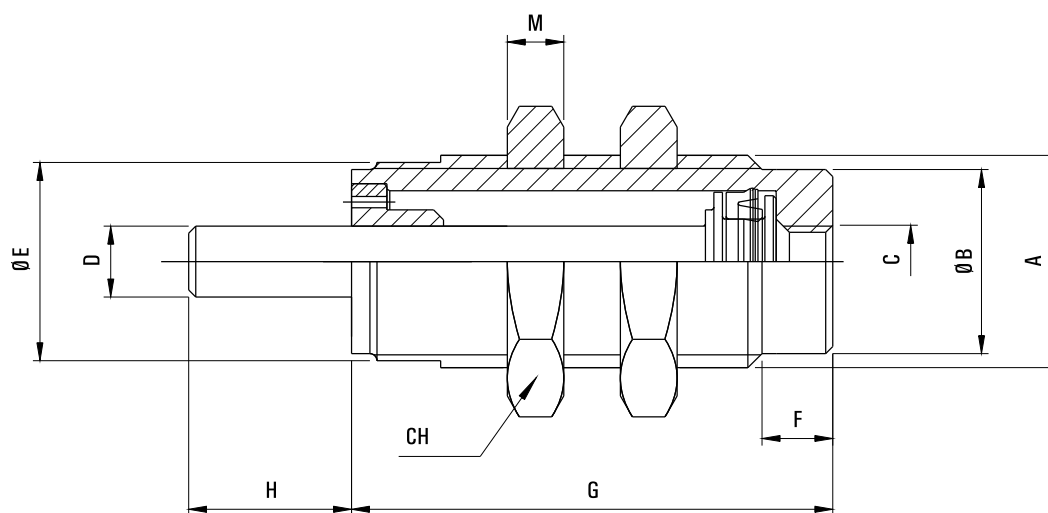

SKU	C-K-010-0005
Producent	Janatics
srednica tloka [mm]	10
skok silownika [mm]	5
dzialanie	powrot sprzyna
zakres cisnienia [bar]	2 - 7
zakres temperatur [C]	-10 - 70
korpus	mosiadz niklowany
tloczynko	stal nierdzewna AISI 303
uszczelnienia	poliuretan
sprzyna	stal



Ø	A	B	C	D	ØE	F	G (skok 5)	G (skok 10)	G (skok 15)	H	M	CH
6	M10x1	8,5	M5	3	9	5	18,5	25,5	32,5	9	3	14
10	M15x1,5	13	M5	5	14	5	20,5	27	34	11,5	4	19
16	M22x1,5	19	M5	5	20	6	23,5	29,5	36	14	5	27