

SIV300

ISO-0 15407-1 / VDMA 24563
Solenoid / Pneumatic Valves

- 5/2, 5/3
- 26mm Body Width
- Sub-Base or Manifold Mounting Type
- Transition Flow 1000ℓ/min (5bar)

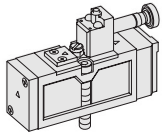

SIV311-IP-***

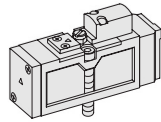

SIP311

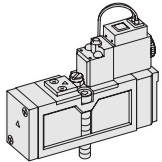

SIV311-IP-SD1-***

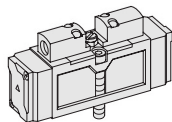

SIP320

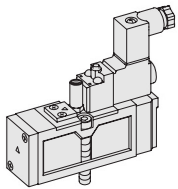

SIV311-EP-SC1-CN1-***

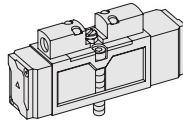

SIP333

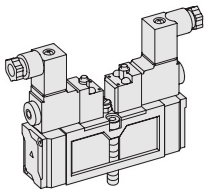

SIV320-IP-SC1-CN1-***

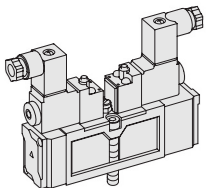
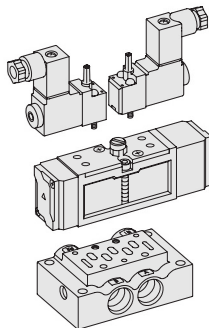

SIV333-IP-SC1-CN1-***

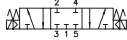

** : Voltage Selection (see page 80)

SPECIFICATION

ITEM	SERIES	SOLENOID, PNEUMATIC	
		5 Port 2 Position	5 Port 3 Position
Fluids		Compressed Air & Inert Gases	
Pressure(bar)		1.5~10.0	2.0~10.0
Eff. Section Area(mm ²)-5bar		18.0	11.0
Ambient & Fluid Temp.		5~60°C (41~140°F)	
Response Time(5bar)		25ms or Less	35ms or Less
Max. Working Frequency		5c/sec	3c/sec
Lubrication		Not Required(Use ISO VG32 #)	
Manual Override		Push Button(Standard), Lever Lock(Option)	
Coil Insulation Class		F-Class or Equivalent	
Permissible Voltage Variation		±10% of Rated Voltage	
Off Min. Residual Voltage		AC:20% or Less / DC:10% or Less	
Power Consumption		Holding-AC:3.5VA(60Hz) / DC:2.5W	

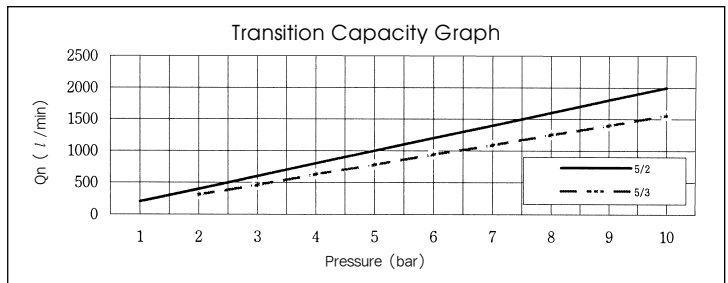

The Material of Parts

- Valve Body : Die-Cast Aluminium
- Spool : Aluminium
- Seals : NBR
- Spring : Stainless
- Cap : Zinc Pressure Die-Cast
- Pilot Parts : Glass Filled Nylon
- Armature : Stainless Steel
- Armature Seals : Viton

* The specification on each item can be amended without any prenotice to improve a performance.
* The specification on each item can be different from actual specification.

ORDERING NO.

SIV3 1 1 - I P - SC1 - CN1 - A2

Valve Series	Function	Return Method	Int/Ext. Pilot	Manual Operator	Solenoid Coil Type	Connector Type	Voltage
SIV3 : Solenoid Valve	1	5/2 Single	0 None	I Internal Pilot	0 None	0 None	0 None
	2	5/2 Double	1 Air + Spring	E External Pilot	SC1 3 Pin Connector Coil	CN1 Normal Connector	A2 AC 220V
	3	5/3 Closed Center	2 Air		SG1 Grommet/Flying Leads	CD1 Connector With LED	A1 AC 110V
SIP3 : Pneumatic Valve	4	5/3 Open Center	3 Spring		SD1 Grommet/Flying Leads With LED	CZ1 Connector With LED & Surge Suppressor	A4 AC 24V
	5	5/3 Pressure Center			SL1 90 Degree Plug-in Wire Assembly With LED		D4 DC 24V
					SM1 180 Degree Plug-in Wire Assembly With LED		D2 DC 12V

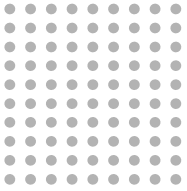

Solenoid & Pilot Actuated Spool Valves

26mm Body Width

5Port 2Position Solenoid Valve

Single Solenoid
SIV311-IP-SG1-***



External Pilot
SIV311-EP-SG1-***

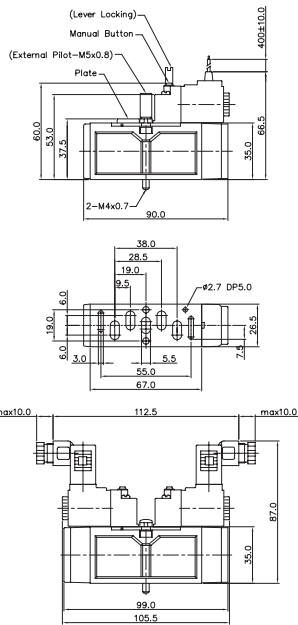
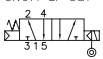

Double Solenoid
SIV320-IP-SC1-CN1-***



5Port 2Position Pneumatic Valve

Single Pneumatic
SIP311

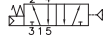

Double Pneumatic
SIP320

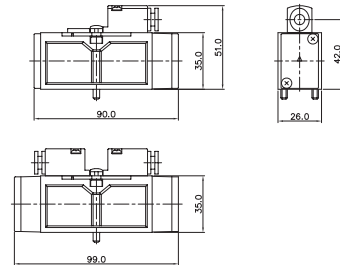
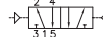

5Port 3Position Pneumatic Valve

Closed Center
SIP333

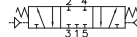

Exhaust Center
SIP343



Pressure Center
SIP353

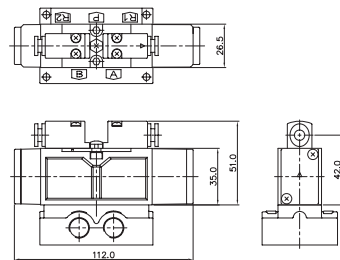
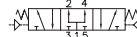

5Port 3Position Solenoid Valve

Closed Center
SIV333-IP-SC1-CN1-***

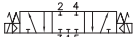

Exhaust Center
SIV343-IP-SC1-CN1-***

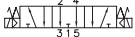

Pressure Center
SIV353-IP-SC1-CN1-***

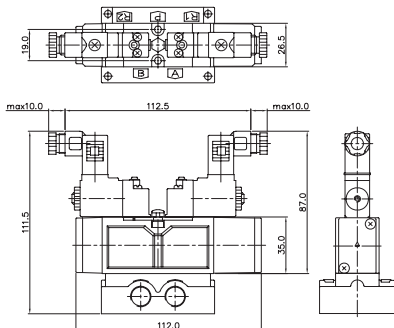
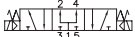

Sub Base Ordering Code

SIB3			1		S	
Base Series	Port & Thread		Function			
SIB3	0	None	S	Single Station Sub Base, 1/4 Port Without Pilot Ports		
SIV300 Solenoid Valve	1	G	SP	Single Station Sub Base, 1/4 Port With Pilot Ports		
	2	NPT	DB	Double Modular Sub Base, 1/4 Port Without Pilot Ports		
			DC8	Double Modular Sub Base, Ø8 One-Touch Fitting		
			E	End Cover, 1/4 Port		
			EB	End Blanking Cover		

SIB30 SINGLE, DOUBLE SUB BASE

(SIV300 Solenoid & Pneumatic Valve Use Sub Base)

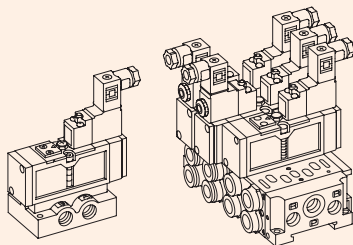

Single Station Sub Base Dimension

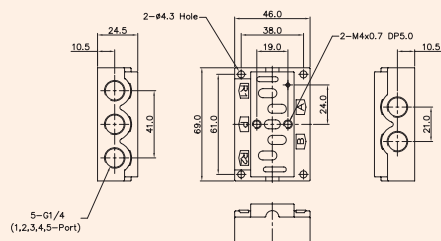

Double Modular Sub Base Dimension

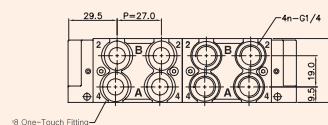
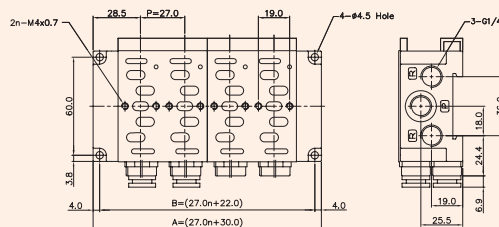

DOUBLE MODULAR SUB BASE DIMENSION mm/STATION

ITEM	2	4	6	8	10
A	76.0	130.0	184.0	238.0	292.0
B	84.0	138.0	192.0	246.0	300.0

Ordering Code SIB30-BLK		Blanking Plate (Material: STS304)
Ordering Code SIB31-E		End Cover, 1/4 (Material: Al)
Ordering Code SIB30-EB		End Blanking Cover (Material: Al)
Ordering Code SIB31-DB		Double Modular Sub Base, 1/4 (Material: Al)
Ordering Code SIB30-DC8		Double Modular Sub Base Ø8 one-touch fitting (Material: Al)