

Przepustnica typu WAFER DN100 - PN10/16

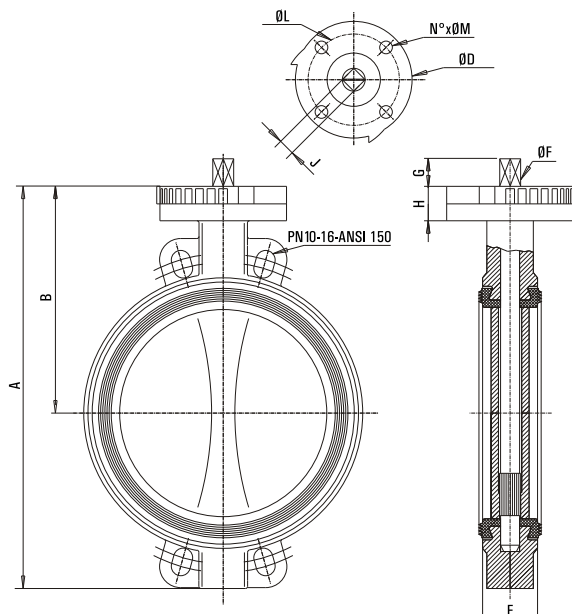

SKU	PGV-20W94E.DN100
Producent	Pneumatig
srednica	DN100
cisnienie robocze	PN10, PN16
dlugosc zabudowy	ISO 5752 seria 20
kolnierz gorny	ISO 5211



DN		A	B	ØD	E	F	G	H	J	ØL	ØM	ISO 5211
mm	-											
32	1 1/4"	206	140	88	33	9.5	14	24	8	70	4x9	F05-07
40	1 1/2"	206	140	88	33	9.5	14	24	8	70	4x9	F05-07
50	2"	228	156	88	43	9.5	14	24	8	70	4x9	F05-07
65	2 1/2"	248	161	88	46	12	16	24	9	70	4x9	F05-07
80	3"	265	169	88	46	14	16	24	11	70	4x9	F05-07
100	4"	298	187	88	52	14	20	24	11	70	4x9	F05-07
125	5"	331	206	105	56	17	20	24	14	70	4x9	F07
150	6"	349	215	105	56	17	20	24	14	70	4x9	F07
200	8"	430	255	105	60	21	24	24	17	70	4x9	F07
250	10"	461	248	150	68	23	24	20	19	102	4x11	F10
300	12"	524	280	150	78	26.5	24	20	22	102	4x11	F10
250	14"	570	300	170	78	26.5	29	20	22	140	4x18	F14
400	16"	644	340	170	102	33	29	20	27	140	4x18	F14