

Zawor zwrotny do próżni 3/4"

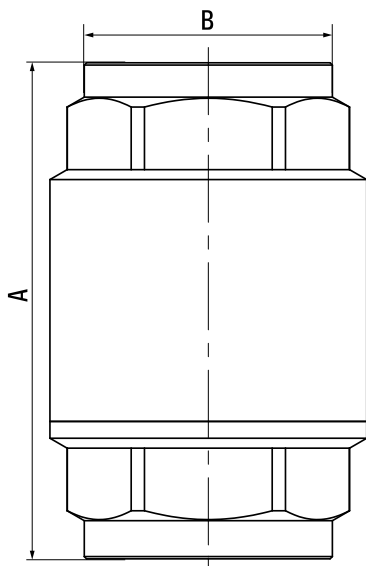

SKU	PA-RUCK34VU
Producent	Pneumatig
przyłącze	G 3/4"
medium	sprezone powietrze, gazy obojetne, oleje, woda, próżnia
zakres ciśnienia [bar]	-1 - 25
zakres temperatur [C]	-20 - 100



MODEL	PRZYŁĄCZE	A	B	bar
PA-RUCK12VU	1/2" (DN 15)	58,5	34,5	25
PA-RUCK34VU	3/4" (DN 20)	65	41,5	25
PA-RUCK10VU	1" (DN 25)	74,5	48	25
PA-RUCK114VU	1 1/4" (DN 32)	83	60,5	18
PA-RUCK112VU	1 1/2" (DN 40)	93	71	18
PA-RUCK20VU	2" (DN 50)	101	87	18