

Silownik kompaktowy UNITOP 020 X 040

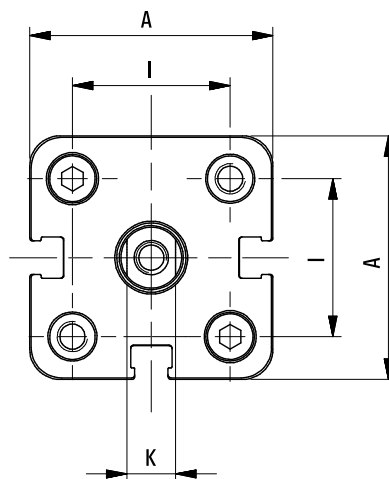

SKU	C-U-020-0040
Producent	Pneumatig
srednica tloka [mm]	20
skok silownika [mm]	40
przylacze	M5
dzialanie	dwustronne
zakres cisnienia [bar]	1 - 10
zakres temperatur [C]	-10 - 70
korpus	aluminium anodyzowane
pokrywy	aluminium anodyzowane
tloczynsko	stal nierdzewna AISI 303
uszczelnienia	poliuretan + NBR
amortyzacja	mechaniczna

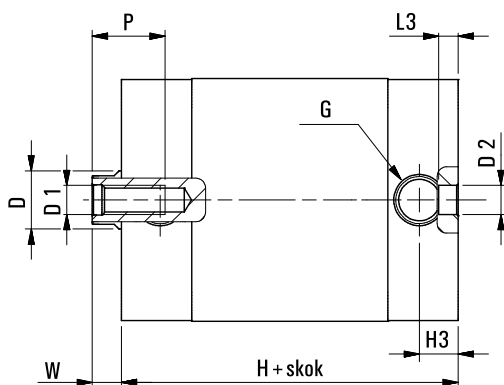

Ø	A	ØD	ØD1	ØD2	G	H	H3	I	K	L3	P	W
20	36	10	M5	6	M5	38	8	22	8	4	12	4,5
25	40	10	M5	6	M5	39,5	8	26	8	4	12	5,5