

Prowadnica silownika C-G 100x1000

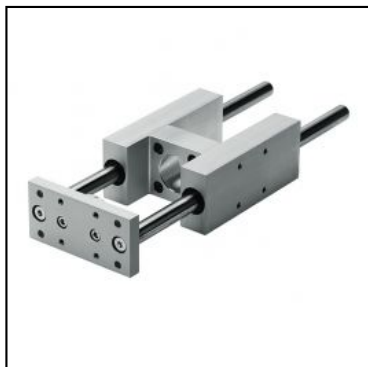

SKU	C-G-100-1000
Producent	Pneumatig
srednica tloka [mm]	100
skok silownika [mm]	1000
zakres cisnienia [bar]	1 - 10
zakres temperatur [C]	-10 - 70
korpus	aluminium anodyzowane

