

Blokada tłoczyska do silownika O40

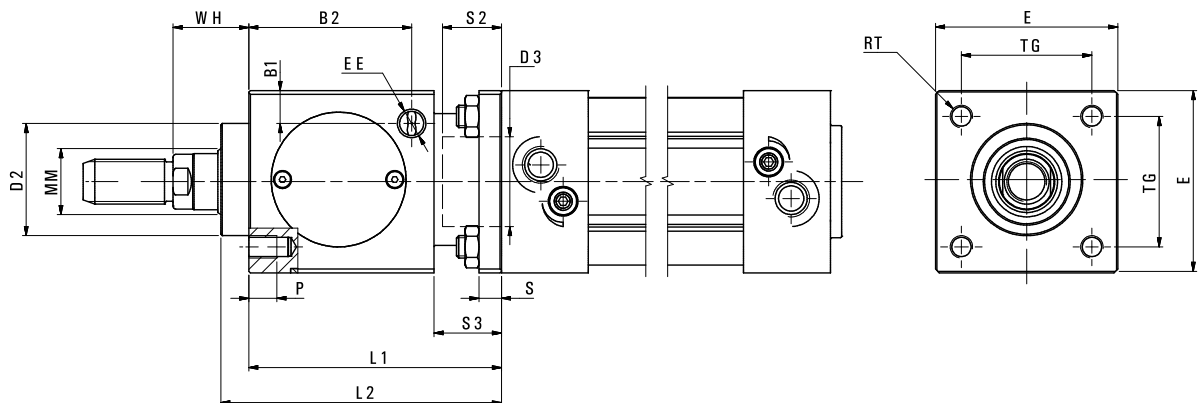

SKU	C-BH-040
Producent	Pneumatig
zakres ciśnienia [bar]	3 - 6
siła blokująca [N]	1240
przyłącze	G 1/8"
zakres temperatur [C]	-5 - 80



Ø	B1	B2	D2	D3	E	EE	L1	L2	MM	P	RT	S	S2	S3	TG	WH
32	9	33,25	30	30,5	47	1/8"G	60	67,5	12	8	M6	6	19,5	20	32,5	26
40	9	42,5	34,9	35,5	54	1/8"G	70	80	16	8	M6	6	22,5	20	38	30
50	12,5	58	40	40,5	65	1/8"G	90	100	20	12	M8	8	29	24	46,5	37
63	17,5	59	45	45,5	75	1/8"G	90	100	20	12	M8	8	29	24	56,5	37
80	17,5	69	45	45,5	95	1/4"G	110	120	25	16	M10	12	37	32	72	46
100	20	69	55	55,5	114	1/4"G	110	120	25	16	M10	12	39	32	89	51
125	19	84,5	60	60,5	138	1/4"G	140	156	32	20	M12	20	51,5	45	110	65