

Silownik kompaktowy UNITOP 080 X 075

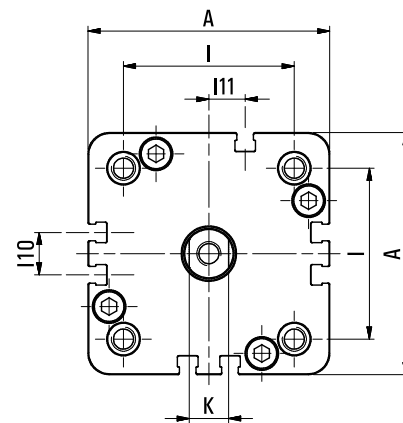

SKU	C-U-080-0075
Producent	Pneumatig
srednica tłoka [mm]	80
skok silownika [mm]	75
przylacze	G 1/8?
działanie	dwustronne
zakres cisnienia [bar]	1 - 10
zakres temperatur [C]	-10 - 70
korpus	aluminium anodyzowane
pokrywy	aluminium anodyzowane
tłoczyisko	stal nierdzewna AISI 303
uszczelnienia	poliuretan + NBR
amortyzacja	mechaniczna

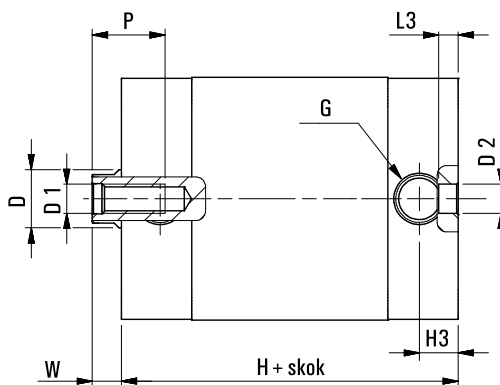

Ø	A	ØD	ØD1	ØD2	G	H	H3	I	I10	I11	K	L3	P	W
63	80	16	M8	8	G1/8	50	8	62	14	12	13	4	17	7,5
80	100	20	M10	8	G1/8	56	8,5	82	18	12	17	4	17	8
100	124	25	M12	8	G1/4	66,5	10,5	103	35	17,5	22	4	22	10