

Silownik kompaktowy UNITOP 063 X 010 M

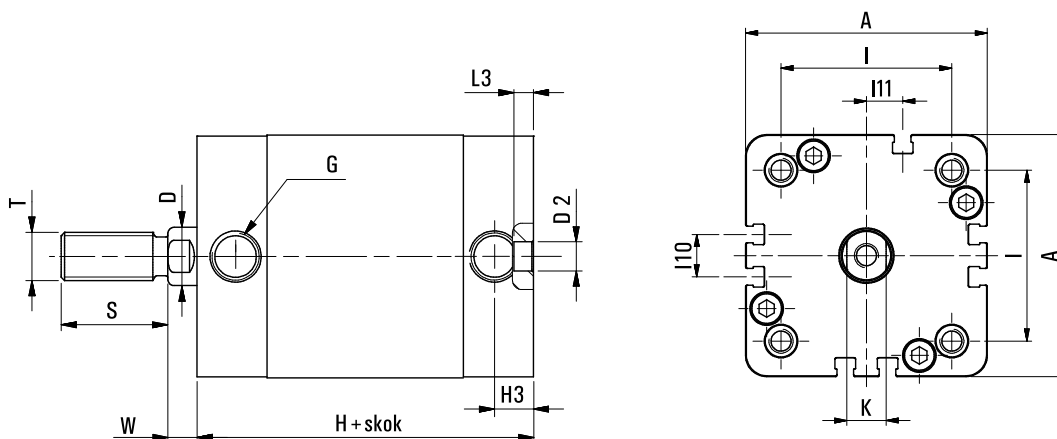

SKU	C-U-063-0010M
Producent	Pneumatig
srednica tłoka [mm]	63
skok silownika [mm]	10
przylacze	G 1/8?
działanie	dwustronne
zakres cisnienia [bar]	1 - 10
zakres temperatur [C]	-10 - 70
korpus	aluminium anodowane
pokrywy	aluminium anodowane
tłoczyisko	stal nierdzewna AISI 303
uszczelnienia	poliuretan + NBR
amortyzacja	mechaniczna



Ø	A	ØD	ØD2	G	H	H3	I	I10	I11	K	L3	S	T	W
63	80	16	8	G1/8	50	8	62	14	12	13	4	24	M12x1,25	7,5
80	100	20	8	G1/8	56	8,5	82	18	12	17	4	32	M16x1,5	8
100	124	25	8	G1/4	66,5	10,5	103	35	17,5	22	4	40	M20x1,5	10