

## Trojnik Y 06mm 1/8"

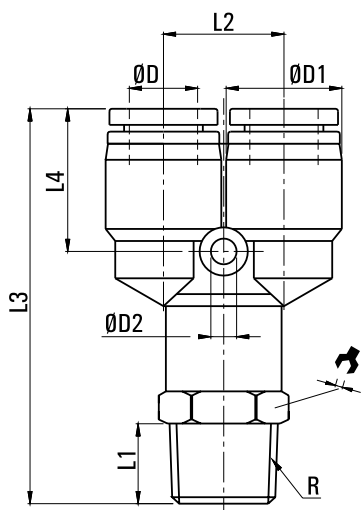

SKU	PU-PWT-06-01
Producent	Hi-Tech
waz	O 6 mm
typ	trojnik Y
przylacze	G 1/8"
rodzaj gwintu	zewnetrzny



MODEL	ØD	R	L1	L2	L3	L4	ØD1	ØD2	↗
PWT-04-M5	4	M5	3.5	11	40	14.5	11.5	3.2	10
PWT-04-01	4	1/8"	7.5	11	42.5	14.5	11.5	3.2	10
PWT-04-02	4	1/4"	9.5	11	45.5	14.5	11.5	3.2	14
PWT-04-03	4	3/8"	10.5	11	47	14.5	11.5	3.2	17
PWT-06-M5	6	M5	3.5	13	41.5	15	13.5	3.2	12
PWT-06-01	6	1/8"	7.5	13	44	15	13.5	3.2	12
PWT-06-02	6	1/4"	9.5	13	46.5	15	13.5	3.2	14
PWT-06-03	6	3/8"	10.5	13	48	15	13.5	3.2	17
PWT-08-01	8	1/8"	7.5	15	46.5	18	15	3.2	14
PWT-08-02	8	1/4"	9.5	15	48.5	18	15	3.2	14
PWT-08-03	8	3/8"	10.5	15	50	18	15	3.2	17
PWT-08-04	8	1/2"	13.5	15	53.5	18	15	3.2	21
PWT-10-01	10	1/8"	7.5	18	56.5	21	19	4.2	17
PWT-10-02	10	1/4"	9.5	18	58.5	21	19	4.2	17
PWT-10-03	10	3/8"	10.5	18	59.5	21	19	4.2	17
PWT-10-04	10	1/2"	13.5	18	63	21	19	4.2	21
PWT-12-01	12	1/8"	7.5	21	59.5	21.5	21.5	4.2	21
PWT-12-02	12	1/4"	9.5	21	62	21.5	21.5	4.2	21
PWT-12-03	12	3/8"	10.5	21	63	21.5	21.5	4.2	21
PWT-12-04	12	1/2"	13.5	21	66	21.5	21.5	4.2	21