

Silownik kompaktowy UNITOP 040 X 020 M

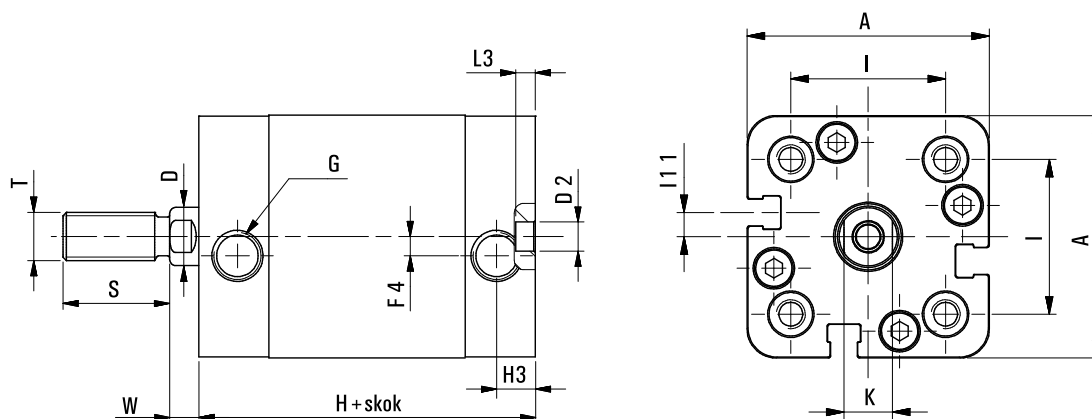

SKU	C-U-040-0020M
Producent	Pneumatig
srednica tłoka [mm]	40
skok silownika [mm]	20
przylacze	G 1/8?
działanie	dwustronne
zakres cisnienia [bar]	1 - 10
zakres temperatur [C]	-10 - 70
korpus	aluminium anodowane
pokrywy	aluminium anodowane
tłoczyisko	stal nierdzewna AISI 303
uszczelnienia	poliuretan + NBR
amortyzacja	mechaniczna



Ø	A	ØD	ØD2	F4	G	H	H3	I	I11	K	L3	S	T	W
32	50	12	6	4	G1/8	44,5	8	32	5	10	4	22	M10x1,25	6
40	58	12	6	3	G1/8	45,5	8	42	3	10	4	22	M10x1,25	6,5