

## Zasuwa nozowa dwukierunkowa DN300 - PN10/16

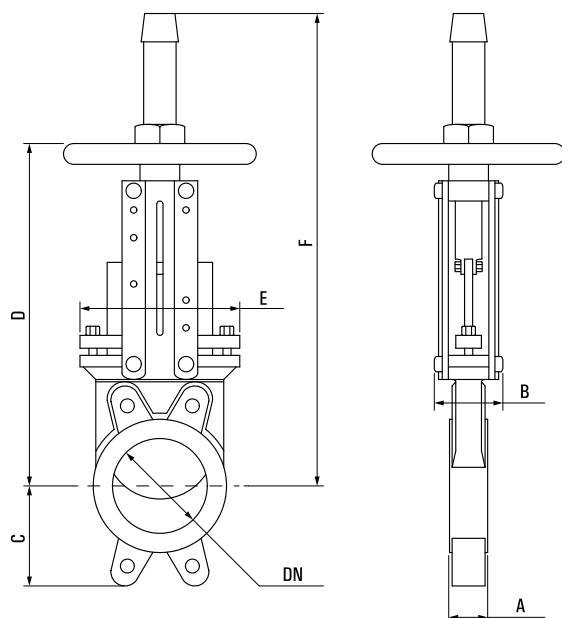

SKU	PG300-2
Producent	Pneumatig
srednica	DN300
cisnienie robocze	PN10, PN16
testowane wg normy	ISO 5208



DN	A	B	C	D	E	F
50	40	92	63	289	124	410
65	40	92	70	316	139	440
80	50	92	92	342	154	460
100	50	92	105	382	174	500
125	50	102	120	415	192	585
150	60	102	130	458	217	637
200	60	120	160	575	270	815
250	70	120	198	676	326	1016
300	70	120	234	776	380	1116
350	96	290	256	906	438	1336
400	100	290	292	1012	493	1442
450	106	290	308	1098	546	1628
500	110	290	340	1210	620	1740