

Silownik kompaktowy DM 040 X 040 A

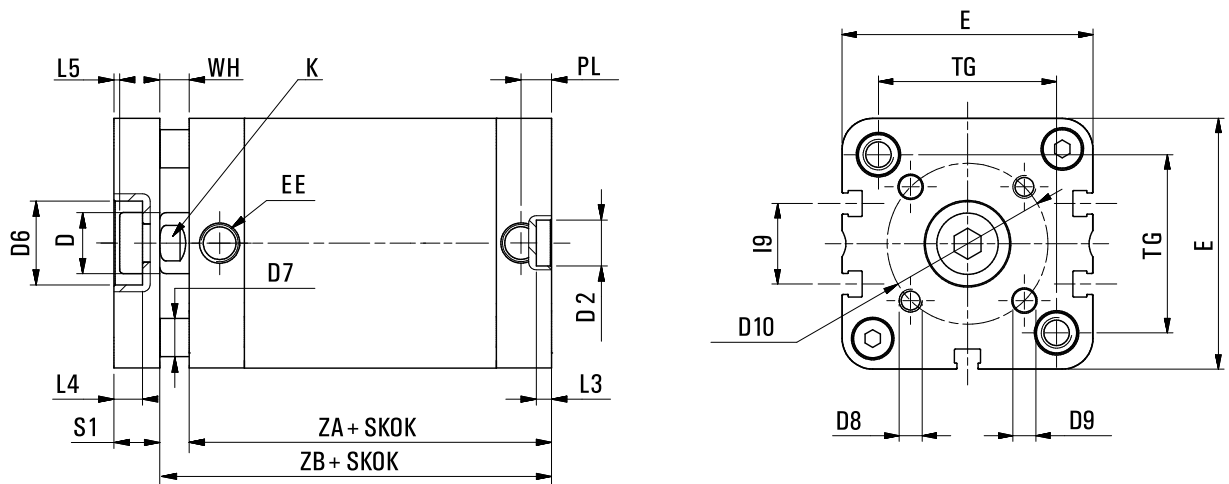

| | |
|------------------------|--------------------------|
| SKU | C-D-040-0040A |
| Producent | Pneumatig |
| srednica tłoka [mm] | 40 |
| skok silownika [mm] | 40 |
| przylacze | G 1/8? |
| działanie | dwustronne |
| zakres cisnienia [bar] | 1 - 10 |
| zakres temperatur [C] | 0 - 80 |
| korpus | aluminium anodyzowane |
| pokrywy | odlew aluminium |
| tłoczyisko | stal nierdzewna AISI 303 |
| uszczelnienia | poliuretan + NBR |
| amortyzacja | mechaniczna |



| Ø | ØD | ØD2 | ØD6 | ØD7 | D8 | ØD9 | ØD10 | E | EE | I9 | K | L3 | L4 | L5 | PL | S1 | TG | WH | ZA | ZB |
|----|----|-----|-----|-----|----|-----|------|------|------|------|----|----|-----|-----|----|----|------|----|----|----|
| 40 | 12 | 9 | 17 | 8 | M5 | 5 | 33 | 54,5 | G1/8 | 12,8 | 10 | 3 | 6,5 | 1,5 | 8 | 10 | 38 | 7 | 45 | 52 |
| 50 | 16 | 12 | 22 | 10 | M6 | 6 | 42 | 65,5 | G1/8 | 21 | 13 | 4 | 7,5 | 1,5 | 8 | 12 | 46,5 | 8 | 45 | 53 |