

Silownik kompaktowy DM 080 X 040 A

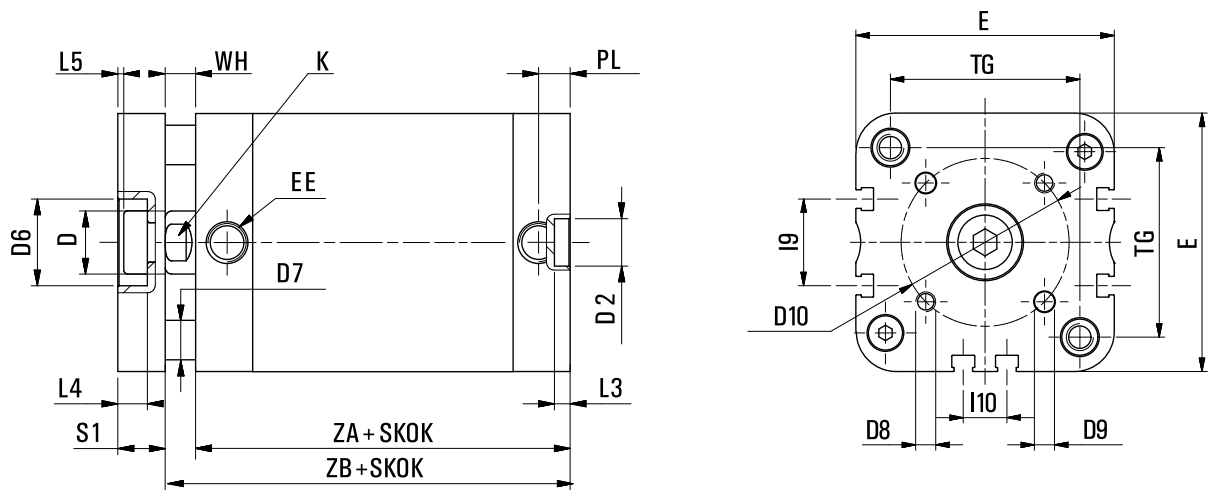

SKU	C-D-080-0040A
Producent	Pneumatig
srednica tłoka [mm]	80
skok silownika [mm]	40
przylacze	G 1/8?
działanie	dwustronne
zakres cisnienia [bar]	1 - 10
zakres temperatur [C]	0 - 80
korpus	aluminium anodowane
pokrywy	odlew aluminium
tłoczek	stal nierdzewna AISI 303
uszczelnienia	poliuretan + NBR
amortyzacja	mechaniczna



Ø	ØD	ØD2	ØD6	ØD7	D8	ØD9	ØD10	E	EE	I9	I10	K	L3	L4	L5	PL	S1	TG	WH	ZA	ZB
63	16	12	22	10	M6	6	50	77	G1/8	25,8	13	13	4	7,5	1,5	7,5	12	56,5	8	49	57
80	20	12	28	14	M8	8	65	95,5	G1/8	30	18	17	4	9	2	8	14	72	9	54	63
100	25	12	28	14	M10	10	80	113,5	G1/8	50	35	22	4	10	3	10,5	14	89	10	67	77