

Silownik kompaktowy DM 040 X 030 M

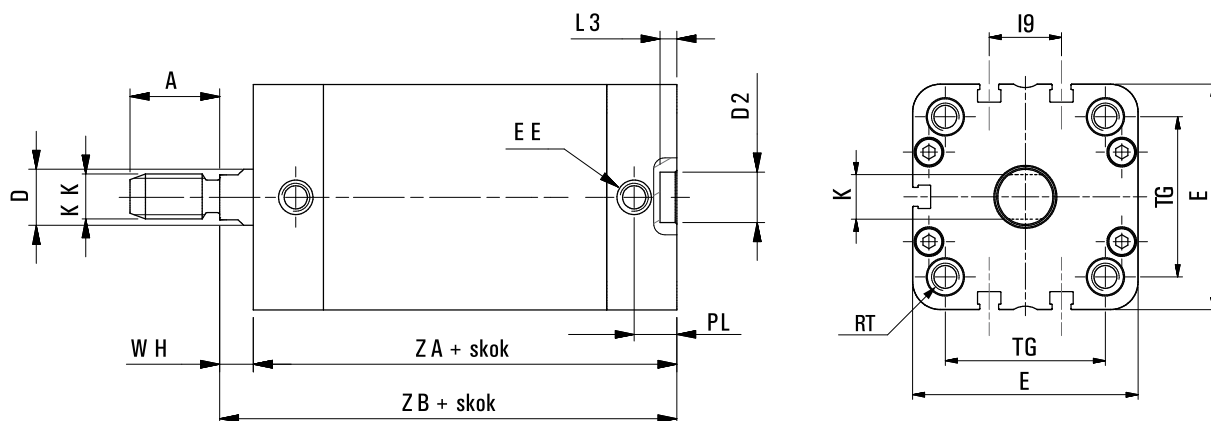

SKU	C-D-040-0030M
Producent	Pneumatig
srednica tłoka [mm]	40
skok silownika [mm]	30
przyłącze	G 1/8?
działanie	dwustronne
zakres ciśnienia [bar]	1 - 10
zakres temperatur [C]	0 - 80
korpus	aluminium anodowane
pokrywy	odlew aluminium
tłoczek	stal nierdzewna AISI 303
uszczelnienia	poliuretan + NBR
amortyzacja	mechaniczna



Ø	A	ØD	ØD2	RT	E	EE	I9	K	KK	L3	PL	TG	WH	ZA	ZB
Ø40	19	12	9	M6	54,5	G1/8	12,8	10	M10 x1,25	3	8	38	7	45	52
Ø50	22	16	12	M8	65,5	G1/8	21	13	M12 x1,25	4	8	46,5	8	45	53