

## Prowadnica silownika C-G 40x600

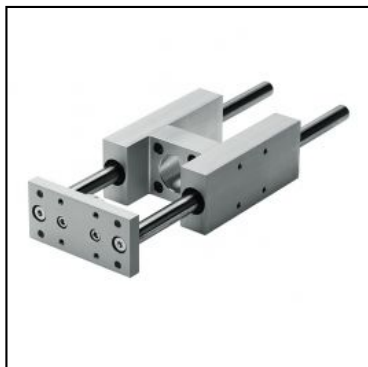

SKU	C-G-040-0600
Producent	Pneumatig
srednica tloka [mm]	40
skok silownika [mm]	600
zakres cisnienia [bar]	1 - 10
zakres temperatur [C]	-10 - 70
korpus	aluminium anodyzowane

