

## Prowadnica silownika C-G 40x170

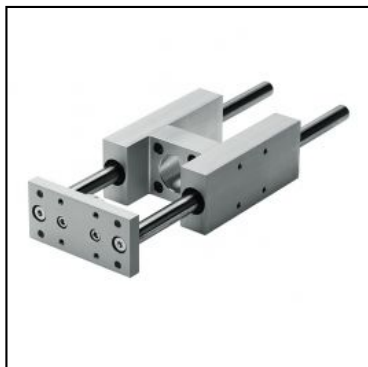

SKU	C-G-040-0170
Producent	Pneumatig
srednica tloka [mm]	40
skok silownika [mm]	170
zakres cisnienia [bar]	1 - 10
zakres temperatur [C]	-10 - 70
korpus	aluminium anodyzowane

