

## Prowadnica silownika 32 x 563

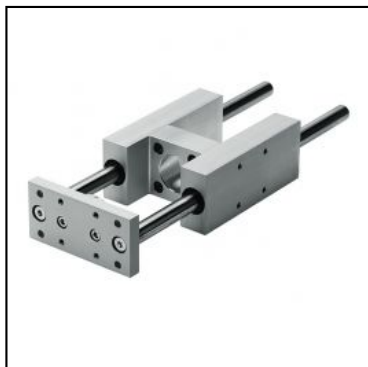

SKU	C-G-032-0563
Producent	Pneumatig

