

Prowadnica silownika 32 x 523

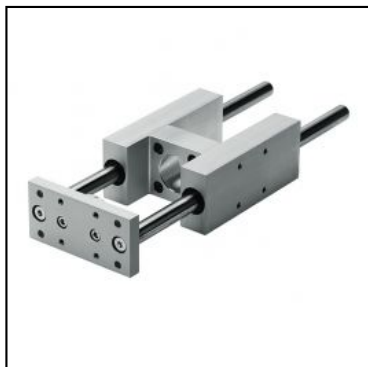

SKU	C-G-032-0523
Producent	Pneumatig

