

## Silownik kompaktowy jednostronnego działania 080 X 030 R

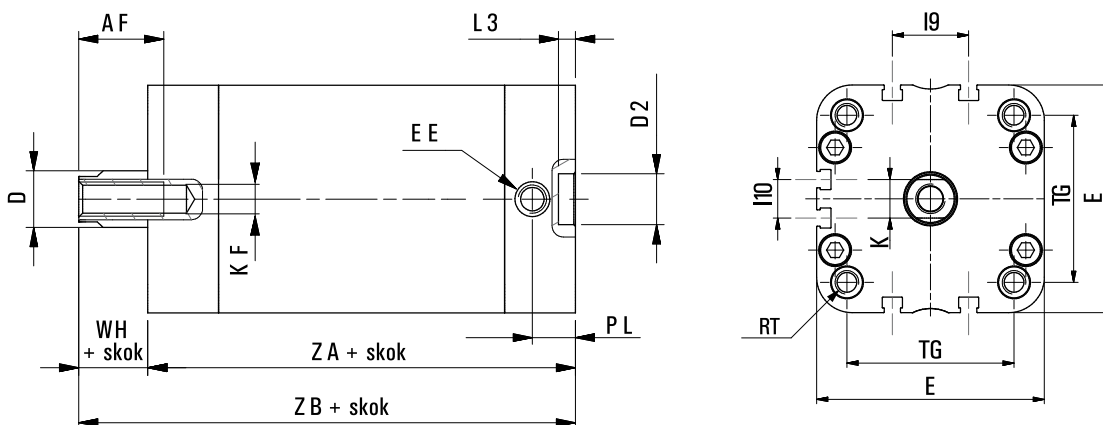

SKU	C-D-080-0030R
Producent	Pneumatig
srednica tłoka [mm]	80
skok silownika [mm]	30
przyłącze	G 1/8?
działanie	wysuw sprężyna
zakres ciśnienia [bar]	2 - 10
zakres temperatur [C]	0 - 80
korpus	aluminium anodowane
pokrywy	odlew aluminium
tłoczek	stal nierdzewna AISI 303
uszczelnienia	poliuretan + NBR
amortyzacja	mechaniczna
sprężyna	stal



Ø	AF	ØD	ØD2	RT	E	EE	I9	I10	K	KF	L3	PL	TG	WH	ZA	ZB
Ø63	17	16	12	M8	77	G1/8	25,8	13	13	M10	4	7,5	56,5	8	49	57
Ø80	20	20	12	M10	95,5	G1/8	30	18	17	M12	4	8	72	9	54	63
Ø100	22	25	12	M10	113,5	G1/8	50	35	22	M12	4	10,5	89	10	67	77